

MBISC6030A

59.5" x 30" x 19"

Installation: Alcove

Material: Acrylic

Plumbed Weight: 105 lbs / 48 kg

Soaker Weight: 85 lbs / 39 kg

Average Fill: 32 gal to above jet level

Maximum Fill: 39 gal to overflow



Options Must be ordered at time of purchase.

Standard White (no charge)
Color Upgrade: Biscuit (MTISCOLOR)

Quick Ship / Priority
 Soaker & Whirlpool (QSHIPMTIS)
 Airbath (QSHIPMTISA)

Inline Heater
 For Whirlpool (HTRMTIS) uses existing pump
 For Soaker & Air Bath (MBHTISOAK) heater with recirculating pump

Accessories.

Lift and Turn Drain & Overflow
 Chrome (MBWOC), White (MBWOW),
 Brushed Nickel (MBWOBN)

Pillows
 Soft Pillow
 White (MBPSW) Black (MBPSB)
 Roll-Up Pillow
 Light Aqua (MBPRUC) Black (MBRUB)

Package	Package Content	Part #
Soaker	Soaking bath - No jets. Integral front skirt, 3-sided integral tile flange and textured bottom.	MBSISC6030A
Air Bath	12 air jets, heated air blower, pre-leveled foam base, textured bottom, integral front skirt and 3-sided tile flange. pre-leveled foam base increases overall tub height 2"-3"	MBAISC6030A
Whirlpool	6 point-massage jets, 1-bhp pump, integral front skirt, 3-sided integral tile flange and textured bottom.	MBWISC6030A

Shown with Whirlpool Package

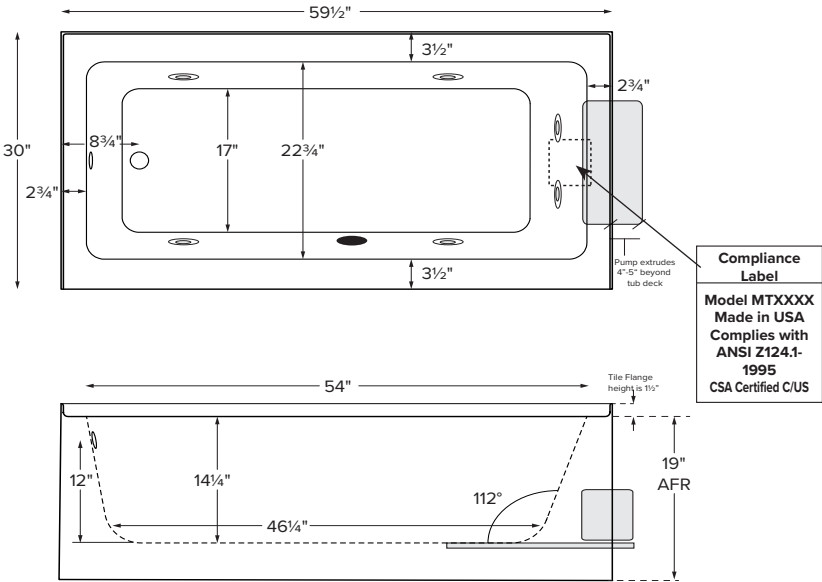

Important Ordering and Installation Information

- Before ordering or installing, consider access to equipment.
- Integral flat front skirt is not removable.
- Must specify left- or right-hand drain when ordering.
- Use proper bedding compound to fully level and support the tub.
- Tubs equipped with an air system or factory installed pre-leveled foam base are designed to install directly onto a flat level subfloor.
- Location of all therapy components is predetermined and cannot be changed.
- Suction and control locations may vary.
- Options listed cannot be combined with Designer Collection options.

Hydrotherapy Package	Components Included	GFCI / 110V
Soaker with Optional Inline Heater	1/2-bhp pump, inline heater	1-15 amp
Whirlpool or Air Bath	1-bhp pump	1-15 amp
Whirlpool with Optional Inline Heater	1-bhp pump, inline heater	1-20 amp
Air Bath with Optional Inline Heater	heated blower, 1/2-bhp pump, inline heater	2-15 amp

CSA Certified C/US; ANSI Z124.1 and ANSI 112.19.7
NOTE: Filling this tub to the maximum may require an above average size or dedicated water heater.

• Before discarding tub crate, check for accessories that may be packaged inside.
 • All product measurements are ±1/2".
 • Specifications and configurations are subject to change without notice.
 • Measurements herein supersede all others published prior to publication date below.

