

Marlborough Freestanding Bathtub

MAR-N-SW-OF + MAR-B-SW-OF

Top view

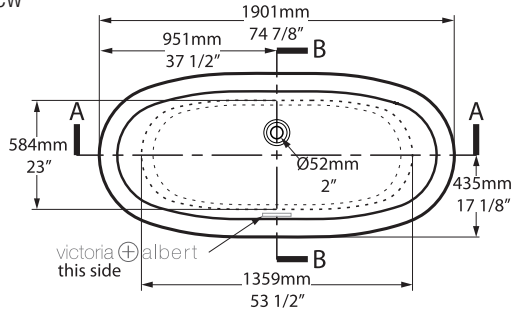

Front view

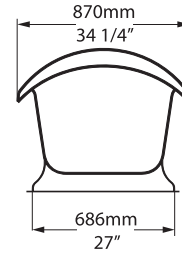

Side view

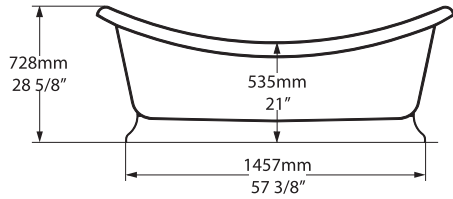

Section BB

Front View

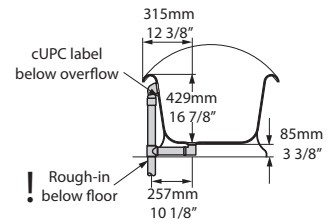

Section AA

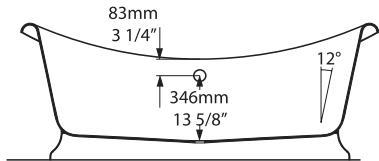

Rim detail

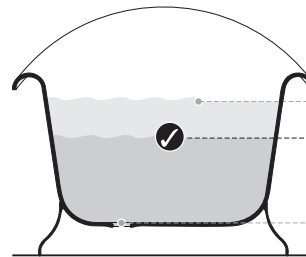
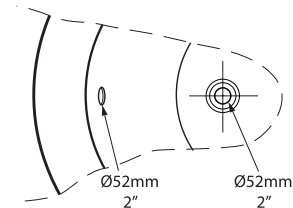
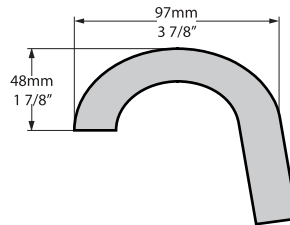

- 708 63% US gal
- 553 45% US gal
- 176 0 US gal

BV-2.1_0048

Recommended drain: K-50-xx

Drain Void: Features a void space underneath the bathtub for drain plumbing.

• All measurements subject to +/-5% tolerance
OF = overflow hole

25
years

25 year warranty for residential use (unpainted product)
Garantie de 25 ans pour un utilisation résidentiel (produit non peint)
Garantía de 25 años para uso domestico (productos no pintados)

5
years

5 year warranty on drains
Garantie de 5 ans sur les drains
Garantía de 5 años para los drenajes

8
years

8 year warranty for commercial use (unpainted product)
Garantie de 8 ans pour un usage commercial (produit non peint)
Garantía de 8 años para uso comercial (productos no pintados)

2
years

2 year warranty on painted exterior
Pour les finitions extérieures peintes la garantie est de 2 ans
Acabados de pintura exterior tienen una garantía de 2 años



Massachusetts Code: Approved
cUPC listing by IAPMO: File No. 6574

