

Fixture Type: _____

Catalog Number: _____

Project: _____

Location: _____

Repose

Wall Sconce 3500K

Model & Size	Color Temp & CRI	Finish	Watt	LED Lumens	Delivered Lumens	Title 24
WS-34027 27"	3500K 90	AL Aluminum	22W	1493	1356	YES

Example: **WS-34027-AL**

DESCRIPTION

Elaborate and embossed. Powerful illumination with enchanting sparkle and charm.

FEATURES

- 5 Year warranty

SPECIFICATIONS

Color Temp:	3500K
Input:	120-277 VAC, 50/60Hz
CRI:	90
Dimming:	ELV: 100-10%, 0-10V: 100-5%, TRIAC: 100-5%
Rated Life:	50000 Hours
Mounting:	Can be mounted on wall in all orientations
Standards:	ETL, cETL, Title 24: 2019 Damp Location Listed
Construction:	Aluminum hardware with acrylic diffuser

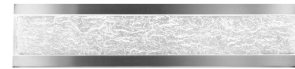

FINISHES



Aluminum

LINE DRAWING

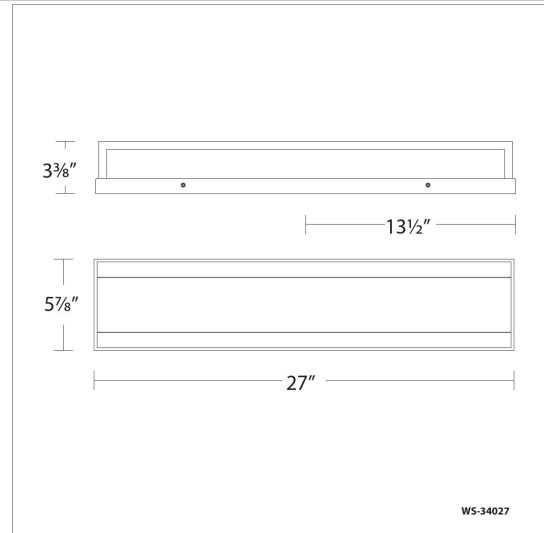

Fixture Type: _____

Catalog Number: _____

Project: _____

Location: _____

Repose Wall Sconce 3500K

Model & Size	Color Temp & CRI	Finish	Watt	LED Lumens	Delivered Lumens	Title 24
WS-34037 37"	3500K 90	AL Aluminum	30W	2122	1785	YES

Example: **WS-34037-AL**

DESCRIPTION

Elaborate and embossed. Powerful illumination with enchanting sparkle and charm.

FEATURES

- 5 Year warranty

SPECIFICATIONS

Color Temp:	3500K
Input:	120-277 VAC, 50/60Hz
CRI:	90
Dimming:	ELV: 100-10%, 0-10V: 100-5%, TRIAC: 100-5%
Rated Life:	50000 Hours
Mounting:	Can be mounted on wall in all orientations
Standards:	ETL, cETL, Title 24: 2019 Damp Location Listed
Construction:	Aluminum hardware with acrylic diffuser



FINISHES



Aluminum

LINE DRAWING

